

Data Sheet



Article number: 3902150030450

Description: Worm gear
VF 150-F1-30-132B5, without lubrication

Measures

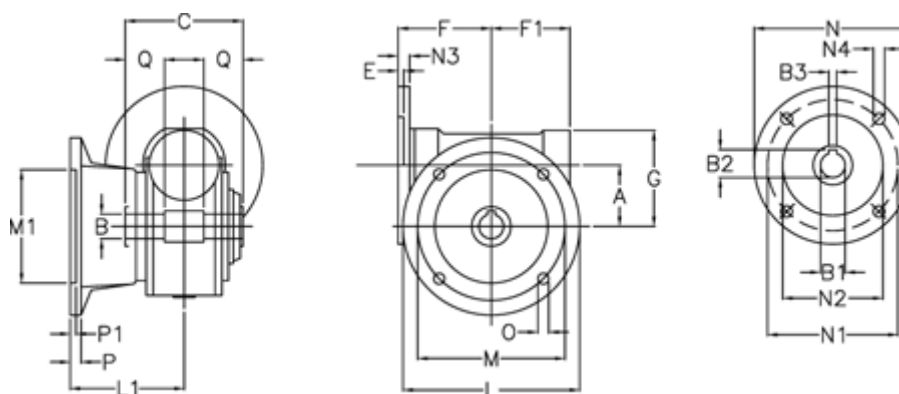

A	= 150	F1	= 179	N2	= 230
B	= 50 H7	G	= 218	N3	= 16
B1 E7	= 38	L	= 350	N4	= 13
B2	= 41.3	L1	= 220	O	= 18
B3 H9	= 10	M	= 290	P	= 22
C	= 175	M1	= 200	P1	= 20
E	= 2	N	= 300	Q	= 55
F	= 190	N1	= 265		